

HRVOJE ČAURAK

DESKHOP

THE USER GUIDE

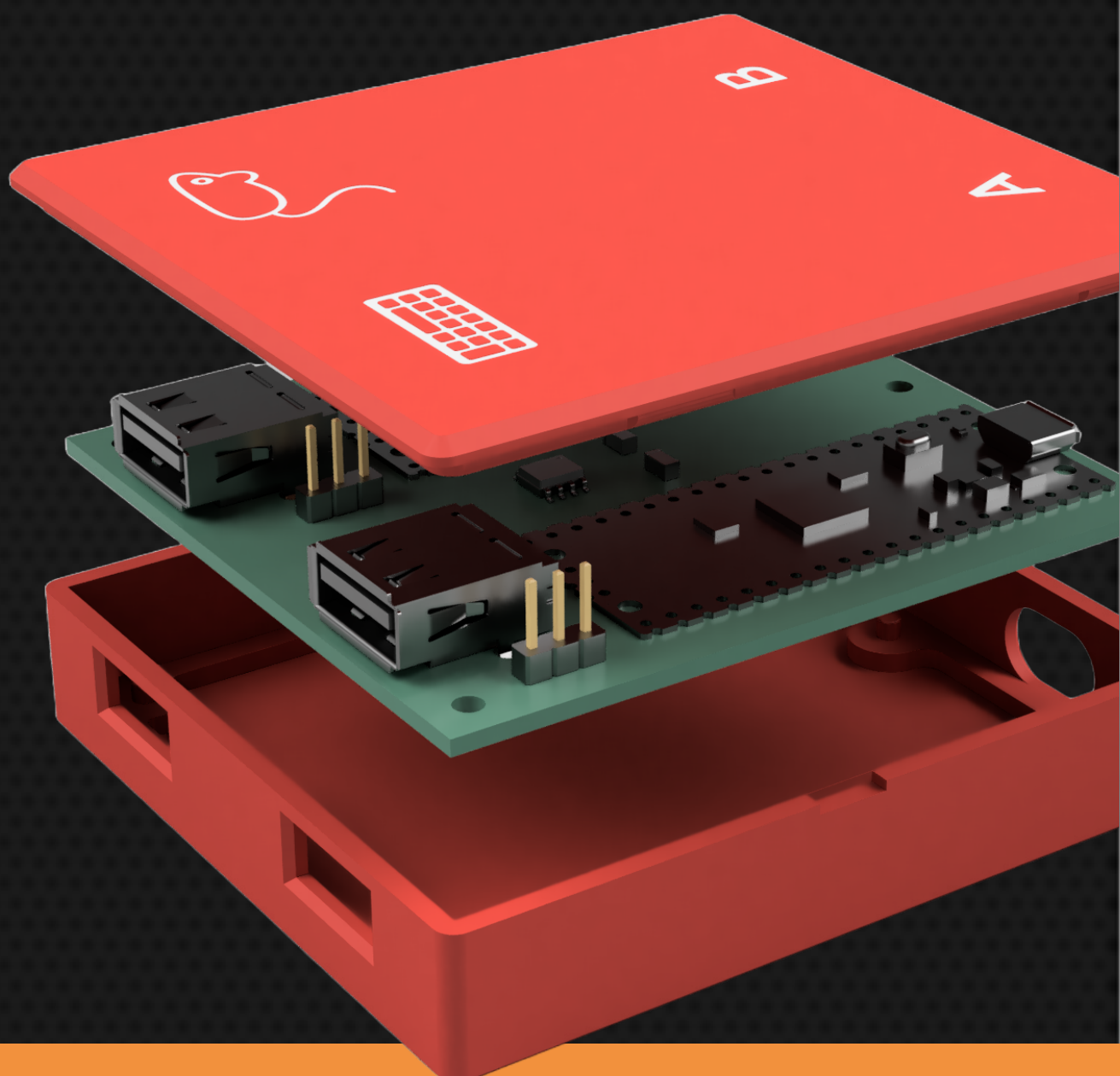

INSTANT SWITCHING SOLUTION

Contents

License Terms	3
Disclaimer Notice	3
Foreword	4
Chapter 1 - Installation	5
Chapter 2 - Use	6
Keyboard Shortcuts	6
Chapter 3 - Configuration	7
Set switching height offset	7
Multi-monitor workarounds	7
Starting config mode	7
Chapter 4 - Firmware Upgrade	9
Initial Firmware Deployment	9
Existing Firmware Upgrade	10
Chapter 5 - Assembly Guide	10
Video guide	10
PCB v1.1 Step-by-Step Assembly	11
Buying the Right Components	13
Chapter 6 - Security and Safety	14
Data Security	14
Hardware Security	14
Access Control	15
Device Protection	15
Transparency	15
Chapter 7 - Troubleshooting	15
Wiring and Assembly	16
Mouse moves weirdly	16
If nothing else works	16
Appendix 1 - Schematics and Drawings	16
Documentation Release History	19

DeskHop User Manual, First Edition

by Hrvoje Čavrak, copyright (c) 2024

 DE000149

This manual covers DeskHop project (<https://github.com/hrvach/deskhop>) and is licensed under Creative Commons Attribution NoDerivatives (CC BY-ND 2.0). Project is certified by the Open Source Hardware Association as being fully open.

License Terms

You are free to copy and redistribute the material in any medium or format for any purpose, even commercially. The licensor cannot revoke these freedoms as long as you follow the license terms. You must give appropriate credit, provide a link to the license, and indicate if changes were made. You may do so in any reasonable manner, but not in any way that suggests the licensor endorses you or your use. If you remix, transform, or build upon the material, you may not distribute the modified material. You may not apply legal terms or technological measures that legally restrict others from doing anything the license permits.

Full license text can be found here: <https://creativecommons.org/licenses/by-nd/2.0>

Disclaimer Notice

This technical manual is provided as part of the DeskHop open source project. By utilizing, modifying, or distributing any part of this project or this manual, you agree to the following terms:

DeskHop - open source project, including all associated documentation and software, is distributed in the hope that it will be useful, but WITHOUT ANY WARRANTY; without even the implied warranty of MERCHANTABILITY or FITNESS FOR A PARTICULAR PURPOSE. In no event shall the contributors be liable for any claim, damages, or other liability, whether in an action of contract, tort, or otherwise, arising from, out of, or in connection with the software, blueprints, schematics or any other dealings.

You acknowledge that the use of the DeskHop software and the information contained in this manual is at your own risk. The authors and contributors do not assume any responsibility for errors, omissions, or damages resulting from the use of the device or this manual. By proceeding with the assembly, installation, use, or distribution of DeskHop, you signify your agreement to these terms and conditions. If you do not agree with these terms, please do not use the project or this manual.

Your safety is important, and I encourage you to approach this project carefully, taking necessary precautions and assuming personal responsibility for your well-being throughout the process. Please don't get electrocuted, burned, stressed or angry. Have fun and enjoy!

Foreword

Many of us work across multiple computers on a daily basis - perhaps switching between a work laptop and a personal desktop, or managing multiple systems for development and testing. While this approach offers flexibility, it often makes us frustrated with using multiple keyboards or existing USB switches having poor performance.

This device was created as an intermediary between your keyboard/mouse and the computer, establishing and maintaining connections with both computers at once. It then chooses where to forward your mouse and keystrokes to, depending on your selection. Keyboard follows the mouse and vice versa, so just dragging the mouse to the other desktop will instantly switch both.

In this manual, you'll find some guidance covering everything from basic setup, firmware upgrade and advanced configuration options. I've structured the content primarily aimed at newcomers, as experienced users need little guidance. This being an open source project, you are encouraged to contribute - whether through sending patches, bug reports, or feature suggestions. Please allow me to thank you for considering to use this device and I hope it will help your daily work environment remain useful and serve you well in your future endeavours.

Special Thanks to:

- Jan Almeroth
- Mirko Šesto
- Łukasz Siudut
- Kevin P. Fleming
- Ellie Tomkins
- Alexey Korobko
- GitHub users OrpheeGT, chris-010, ak666666, chri2
- Everyone else who contributed in any way

Chapter 1 - Installation

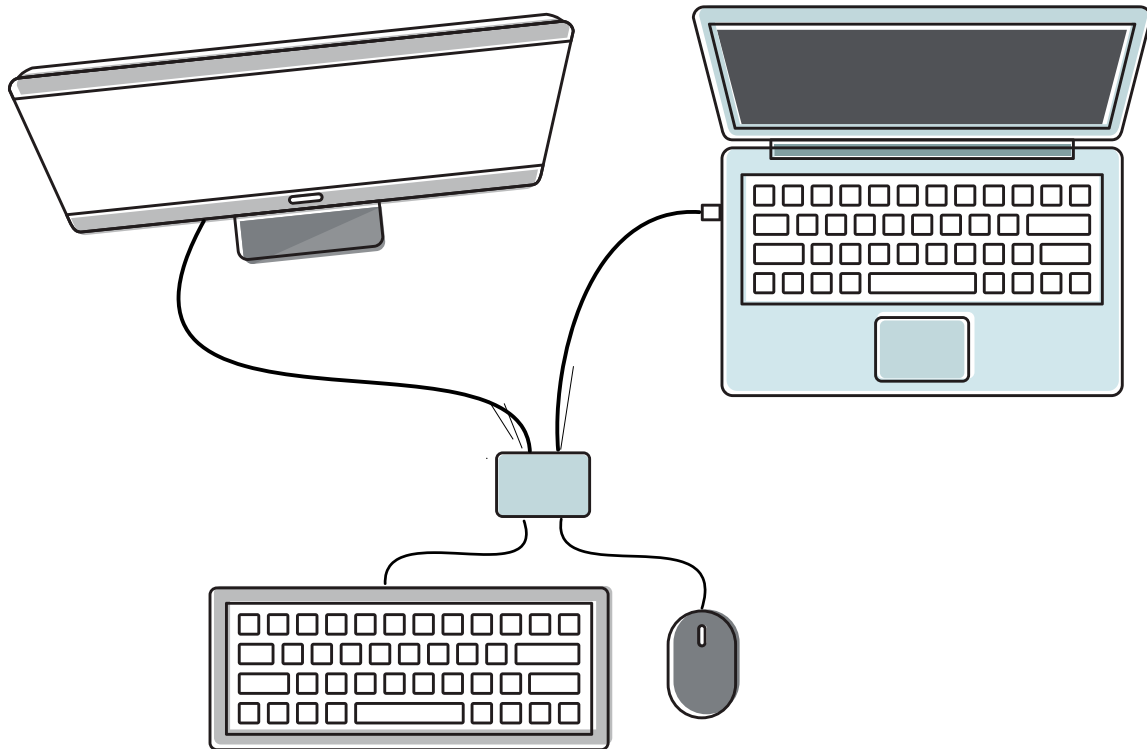

Figure 1: Connection Diagram

- If this is your first bring-up, flash firmware to each board (see chapter 4)
- Connect your mouse to the input USB port with a mouse icon
- Connect your keyboard to the input USB port with a keyboard icon
- Connect outputs to both computers with a micro-USB to USB cable
- Turn both computers on



If everything is connected correctly, device LEDs will flash after you plug in your keyboard/mouse to indicate they are detected. Both computers need to be providing power to the device in order to properly function.

Chapter 2 - Use

Keyboard Shortcuts

During normal operation, these are the keyboard shortcuts you can use to trigger actions,

Action	Shortcut
Enter config mode	Left Ctrl + Right Shift + C + O
Enable screensaver	Left Ctrl + Right Shift + S
Disable screensaver	Left Ctrl + Right Shift + X
Gaming mode - lock to screen, act as standard mouse	Left Ctrl + Right Shift + G
Switch between outputs	Left Ctrl + Caps Lock
Wipe flash config	Right Shift + F12 + D
Save screen height offset	Right Shift + F12 + Y
Toggle slow mouse mode	Right Ctrl + Right Alt
Lock / Unlock mouse to current screen	Right Ctrl + K
Lock both computers at once (needs OS set in config)	Right Ctrl + L

Make sure you're running the latest firmware, otherwise shortcuts might have changed or not implemented in your version.

Toggle **slow mouse mode** makes your mouse cursor move much slower, helping with precision work. Same shortcut turns the mode on and off again.

Gaming mode locks cursor to the current screen and converts the mouse to relative mode. This means it will work for games, virtual machines, multiple desktops etc. but you have to use the keyboard shortcut to switch.

Chapter 3 - Configuration

Set switching height offset

First thing to configure is the switching height offset. Unless you have two identical screens, chances are their heights don't match. To make the mouse pointer come out at the same height on the other screen and improve user experience, it is necessary to tell the system what's the height difference to your screens.

To do this:

1. Leave your mouse cursor on the LARGER screen at the height of the smaller/lower screen (illustrated) and then press Right Shift + F12 + Y. Your LED (and caps lock) should flash in confirmation.
2. Repeat for the bottom border (if needed). This will get saved to flash and it should keep this calibration value from now on.

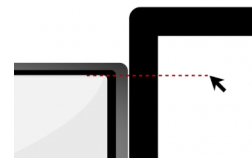

Multi-monitor workarounds

Windows and Mac have issues with multiple screens and absolute positioning, so workarounds are needed (still experimental). There is a better workaround under construction, but for now you have to set the operating system for each output and number of screens.

Your main screens need to be in the middle, and secondary screen(s) on the edges. To configure the actual options, open the web configuration page for your device.

Starting config mode

Starting with fw 0.6, an improved configuration mode is introduced. To configure your device, follow these instructions:

1. Press Left Ctrl + Right Shift + C + O - your device will reboot and enter configuration mode (on the side your keyboard is plugged into). On-board LED and caps lock led will keep blinking during the configuration session.
2. A new USB drive will appear named "DESKHOP" with a single file, config.htm
3. Open that file with Chromium / Chrome. Unfortunately FF is not supported right now, since they avoid implementing WebHID.
4. Click connect and allow deskhop device to pair.

The reason this is served locally instead of a more convenient webpage somewhere online and webhid always available is for security reasons.

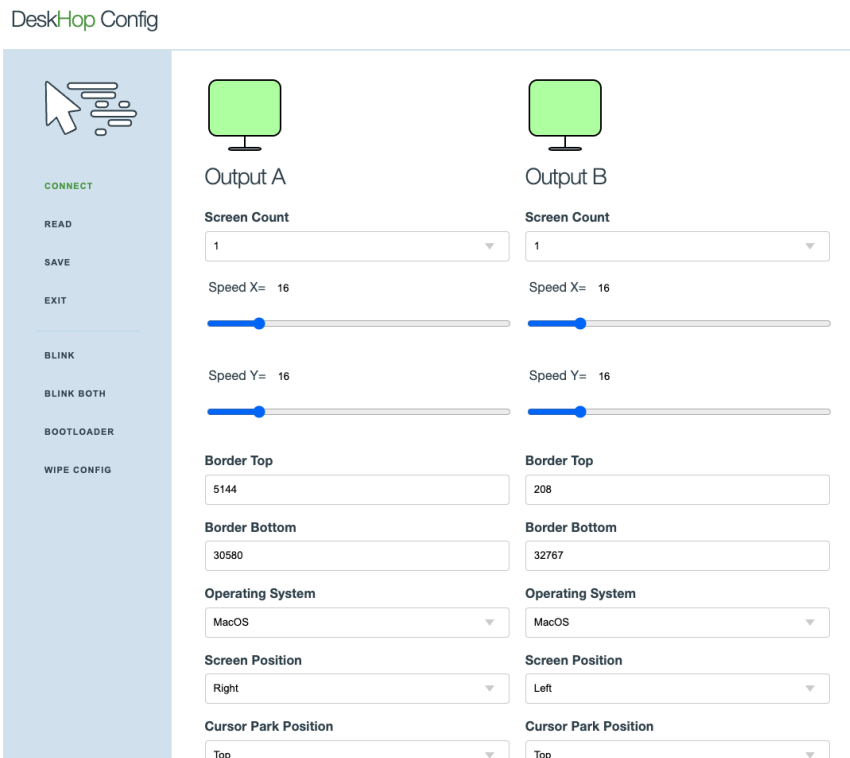

Figure 2: If everything went well, you should be seeing this config page

Any changes you made should be signalled to the device immediately after e.g. moving the slider or losing focus on an input field. To finish configuration, click save and exit.

Explaining the options:

- **Screen count** means how many desktops you have connected.
- **Speed X and Y** allow you to tweak mouse speed on each output
- **Border top** and **bottom** are weird-looking numbers which represent switching height offsets. Recommendation is to configure this using the method described above for simplicity. Values go from 0 (top) to 32767 (bottom).
- **Cursor park position** defines where the cursor will be moved on the computer which is not currently active
- **Screensaver** prevents your computer from sleeping, you can choose pong (cursor bounces around), jitter (cursor moves 1 pixel) or none (off).
- **Idle time** is how soon screensaver kicks in and **max time** is how long is it allowed to run. Both values are in *microseconds*.

- **Force mouse boot mode** initializes the mouse in a simple mode that might make it work in case you're having issues.
- **Enforce ports** is another fix for misbehaving devices.
- **Keyboard led as indicator** allows using caps lock for signalling.



Flashing caps lock LED is there to remind you that the device is in configuration mode. If there is no config activity for a while, your device will reboot back to normal mode for security reasons.

Chapter 4 - Firmware Upgrade

If you just finished soldering your board or got it somewhere pre-assembled, it likely doesn't have any software programmed yet. To make it operational, it is essential to first copy the software you either built yourself or got as the official binary released on GitHub.

Initial Firmware Deployment

1. Go to <https://github.com/hrvach/deskhop/releases> and pick the latest stable release
2. Download the **deskhop.uf2** file
3. For **EACH** of the two Pico boards, hold the BOOTSEL button while plugging in the microusb cable (the other end needs to already be plugged into your computer).

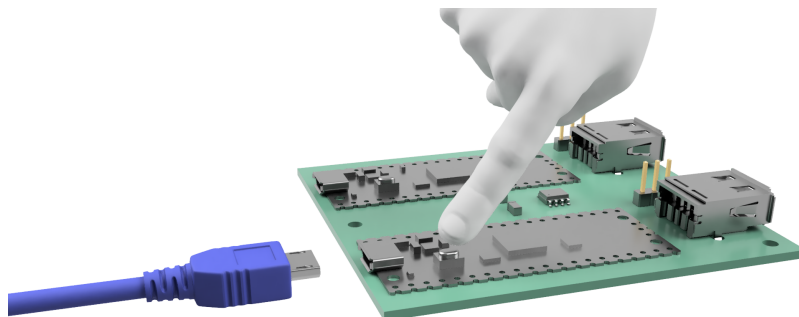

Figure 3: Hold the button while plugging the cable in

4. A new USB storage drive will appear, copy deskhop.uf2 there and unplug the cable
5. Repeat the procedure for the other Pico board

This procedure is your means of recovery in case anything goes wrong at any point. Loader being in ROM, you can always use this procedure to recover from a bad flash or any other issue you might encounter.

Existing Firmware Upgrade

If you're running an existing deskhop firmware already and want to upgrade to a newer release, you need to:

1. Download the **deskhop.uf2** file from **<https://github.com/hrvach/deskhop/releases>**
2. Press LEFT CTRL + RIGHT SHIFT + "c" + "o" to enter config mode
3. USB storage drive will appear (on the output where the keyboard is plugged in), copy deskhop.uf2 to it but don't unplug.
4. First one board will flash, then another. Wait until nothing is flashing anymore and you're done.

When upgrading, it's sufficient to only do one side, the other side will upgrade automatically.

Chapter 5 - Assembly Guide

Video guide

To make assembly easier, there is a video guide to lead you through the process:

https://www.youtube.com/watch?v=LxI9NYi_oOU

It is based on the older board revision v1.0 which is easier to hand-assemble but should provide enough guidance for the newer version as well.

The firmware has been unified in the meantime, so instead of board_A.uf2 and board_B.uf2 mentioned in the video, there is just one file now and the procedure is identical for both Picos.

PCB v1.1 Step-by-Step Assembly

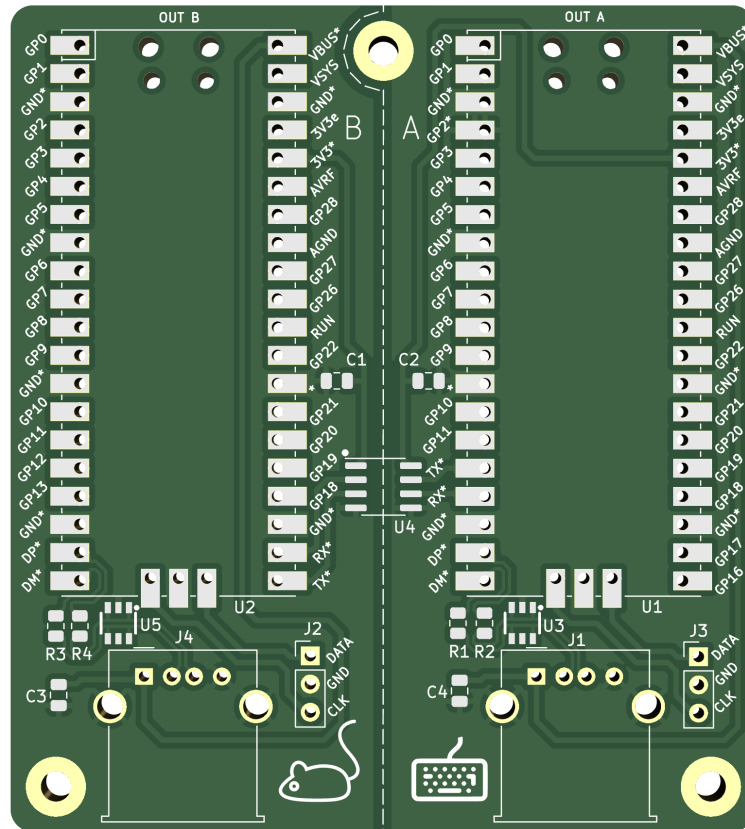

Figure 4: Start with a blank PCB

1. Solder the U3 and U5 ICs first. These are TPD4E1U06 TVS diode arrays here to protect against static electricity discharge that could ruin your board.

They are the hardest to do - the board would still work without them, but it is highly recommended to have them in there. Careful with positioning, solder bridges you'll fix with some flux and solder wick.

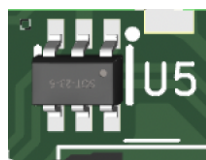

Figure 5: Make sure the dots match (pin 1 is oriented towards the Pico boards)

2. Solder the U4 second, this is the TI ISO7721DR (or ADuM1201) Digital Isolator in SOIC-8, its role is to make sure your computers are isolated from each other.

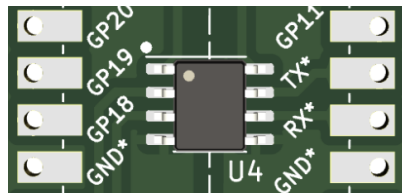

Figure 6: Make sure the dots match (pin 1 is oriented towards out B)

3. Now do R1 - R4, these are 27 ohm, 0805 resistors. Orientation doesn't matter. While at it, also do C3 and C4 - these are 4.7uF capacitors in 0805 size.

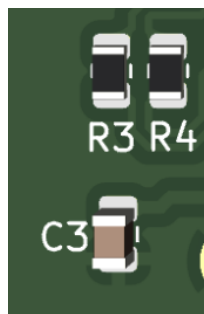

Figure 7: 27 ohm resistors, 4.7uF capacitor

4. Solder C1 and C2, these are 100nF capacitors in 0805, just above U4. Orientation doesn't matter.



Figure 8: 100 nF Capacitors

5. Solder the USB connectors marked J1/J4 and SWD debugging header marked J2/J3, check the video for guidance. J2 and J3 can be omitted if you don't plan to do any debugging.

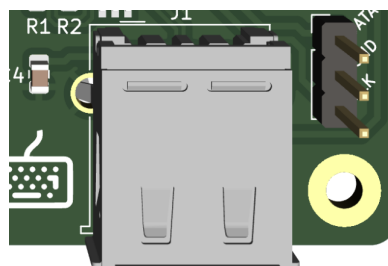

Figure 9: USB connector

- Solder the Picos. Only pins marked with a little asterisk are required but it's ok to solder everything.

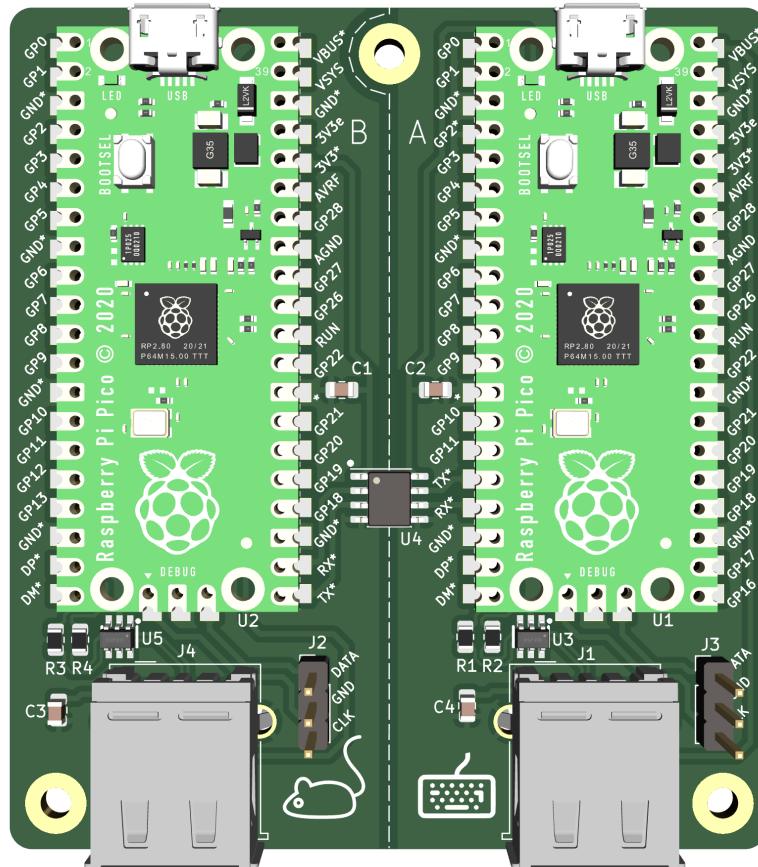

Figure 10: Finished board

First tack one end, make sure it's centered perfectly. If not, reheat and retry. Never solder more than one pin until it is positioned exactly right. Check video for guidance.

Buying the Right Components

This is what you'll need in order to complete the board.

Component	Part	Qty
U1, U2	Raspberry Pi Pico	2
J1, J4	USB-A PCB conn.	2

Component	Part	Qty
U4	TI ISO7721DR (OR ADuM1201BRZ)	1
C1, C2	Cap 0805 SMD 100nF	2
R1, R2, R3, R4	Res 0805 SMD 27ohm	4
U3, U5	TPD4E1U06DBVR	2
C3, C4	Cap 4.7uF SMD 0805	2
J2, J3	Headers 2.54 1x03	2

None of these can be considered rare or hard to obtain, so most online stores (Mouser, DigiKey, Farnell, Reichelt) should have them in stock in sufficient quantities.

Chapter 6 - Security and Safety

Some features are missing on purpose, despite the fact it would make the device easier to use or simpler to configure. Here is a quick breakdown of these decisions:

Data Security

- There is no copy-paste or any information sharing between systems. This prevents information leakage.
- No input history is allowed to be retained.
- No device-initiated keystrokes, for any reason. Only thing that comes out is what you type/trigger.

Hardware Security

- Outputs are physically separated and galvanically isolated with a minimal isolation voltage of 2kV.
- There is no bluetooth or wifi, networking, Internet access, etc.

Access Control

- No webhid device management without explicit user consent. No inbound connectivity from the output computers, with the only exception of standard keyboard LED on/off messages and hard limited to 1 byte of data.
- All packets exchanged between devices are of fixed length, config options transferred are limited to a short list. Most options are read-only. Cross-device firmware upgrades can be disabled.

Device Protection

- No connected computer is considered trusted under any circumstances.
- Configuration mode is automatically disabled after a period of inactivity.
- No plugged-in keyboard/mouse custom endpoints are exposed or information forwarded towards these devices. Their potential vulnerabilities are effectively firewalled from the computer.
- No FW upgrade triggering from the outputs. Only explicit and deliberate user action through a special keyboard shortcut may do that.

Transparency

- Entirety of the code is open source, without any binary blobs and thoroughly commented to explain its purpose. I encourage you to never trust anyone and always make sure you know what you are running by doing a manual audit.

This still doesn't guarantee anything, but I believe it makes a reasonable set of ground rules to keep you safe and protected.

Chapter 7 - Troubleshooting

Hopefully, you're just skipping this chapter. If not, here are some hints that might help you with diagnostics and debugging:

Connect both outputs, then plug in the keyboard to board A. LEDs should flash quickly back and forth. This means board A recognises the keyboard as USB device, and is able to talk to board B and vice-versa.

If both LEDs flash in both cases, all is good!

If only one LED blinks, the board talks to your USB device correctly but cannot send messages to the other board. Check #1 or #2 in Wiring and Assembly section depending on the board.

If no LEDs flash after plugging in, this means board A can't talk to your USB device. Check #4 in Wiring and Assembly section.

Wiring and Assembly

1. Pressing caps-lock toggles leds correctly but mouse only works on output B
 - Check U4 pin 3 connected to pico B pin 21 (GPIO 16)
 - Check U4 pin 6 connected to pico A pin 17 (GPIO 13)
2. Moving the mouse toggles leds correctly but keyboard only works on output A
 - Check U4 pin 2 connected to pico B pin 22 (GPIO 17)
 - Check U4 pin 7 connected to pico A pin 16 (GPIO 12)
3. Keyboard only works on A, mouse only works on B
 - Check both 1 and 2
 - If none of this worked, check the remaining pins on the U4 (3.3v, GND) on both sides.
4. Keyboard/mouse don't work on one or both boards
 - Make sure you have the latest release and plug in the keyboard to board A. If no LEDs flash:
 - Check if Pico pads marked GP14, GP15, VBUS have been soldered.
 - Check if all 4 USB-A pins are soldered correctly.
 - Repeat for board B.

Mouse moves weirdly

Right Shift + F12 + D resets saved settings which might end in resolving your problem if it's due to the wrong config being saved in flash.

If nothing else works

Try reporting your issue on GitHub, we'll do our best to help you out.

Appendix 1 - Schematics and Drawings

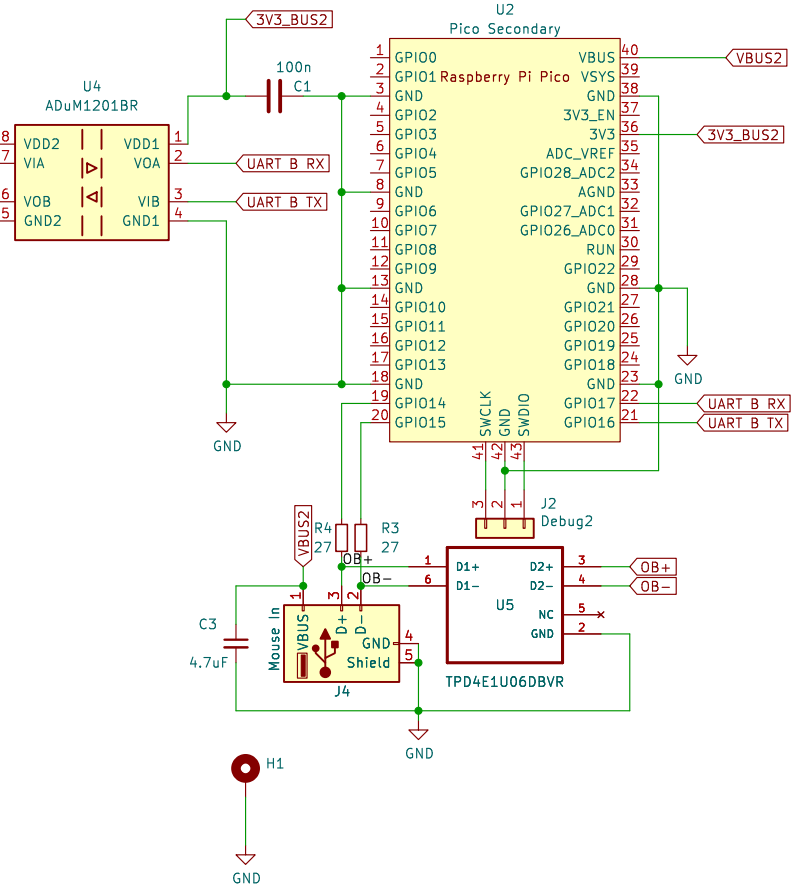
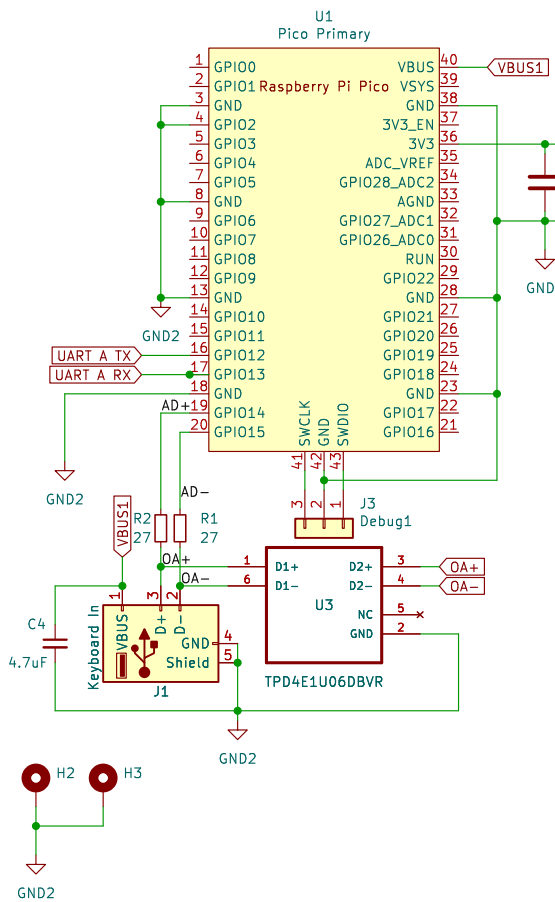

Pico A – GPIO2 Pulled Down to GND
 Added 27 ohm resistors to D+/D-
 Added 4.7 uF caps to VBUS
 Added TPD4E1U06 ESD protectors
 Updated silkscreen soldering markings

Hrvoje Čavrak
 Sheet: /
 File: DeskHop_Rev1.kicad_sch

Title: DeskHop – Fast Keyboard/Mouse Switching Device

Size: A4	Date: 2024-01-11	Rev: v1.1
KiCad E.D.A. kicad 7.0.9		Id: 1/1

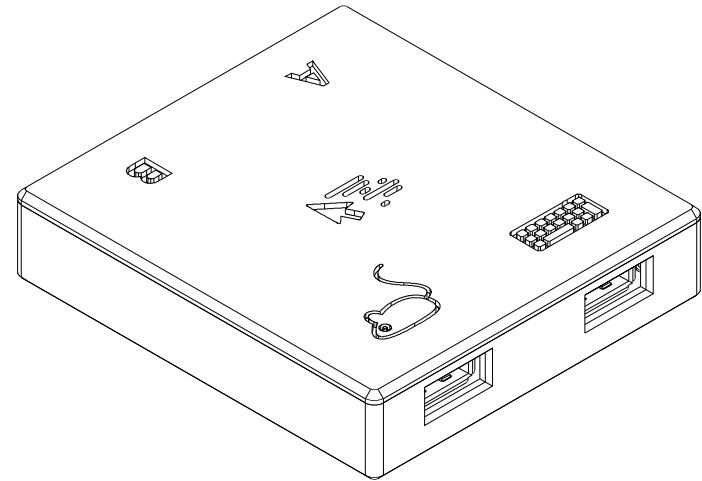
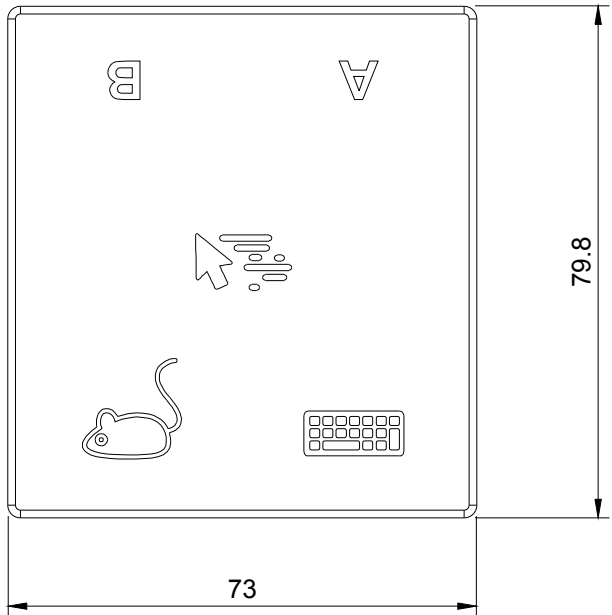
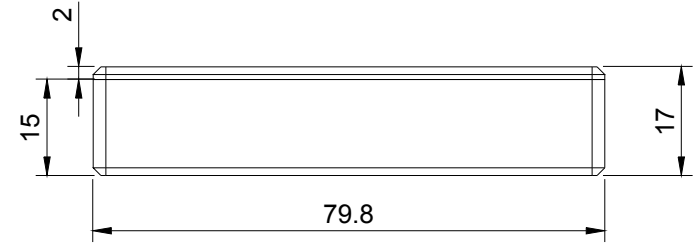
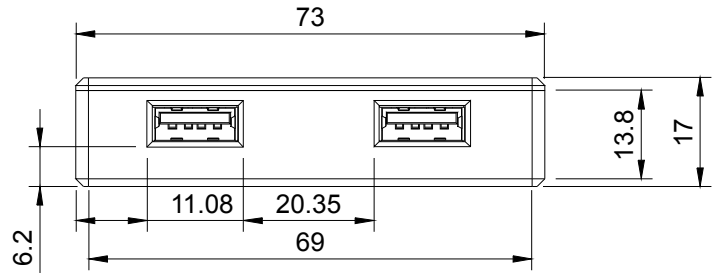

Dept.	Technical reference	Created by Hrvoje Čavrak 24/11/2024	Approved by
		Document type	Document status
		Title DeskHop case	DWG No.
		Rev.	Date of issue
			Sheet 1/1

Documentation Release History

24 Nov 2024

- Initial release

